

# KAWASAKI NINJA 400 (18) - FTRKA007R



RIPOSIZIONARE IL MILLERIGHE  
CON ANGOLI DI SNODO A 90°

RIPOSITIONING THE GEAR ARM  
CREATING 90° DEGREE ANGLE

CAMBIO ROVESCiato  
REVERSE MODE

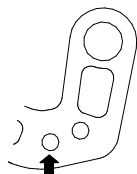
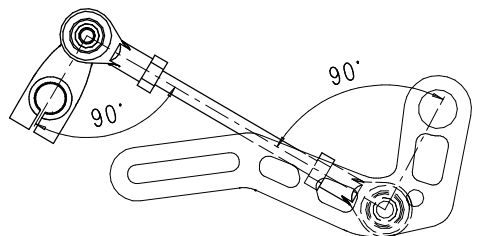

CAMBIO NORMALE  
NORMAL MODE

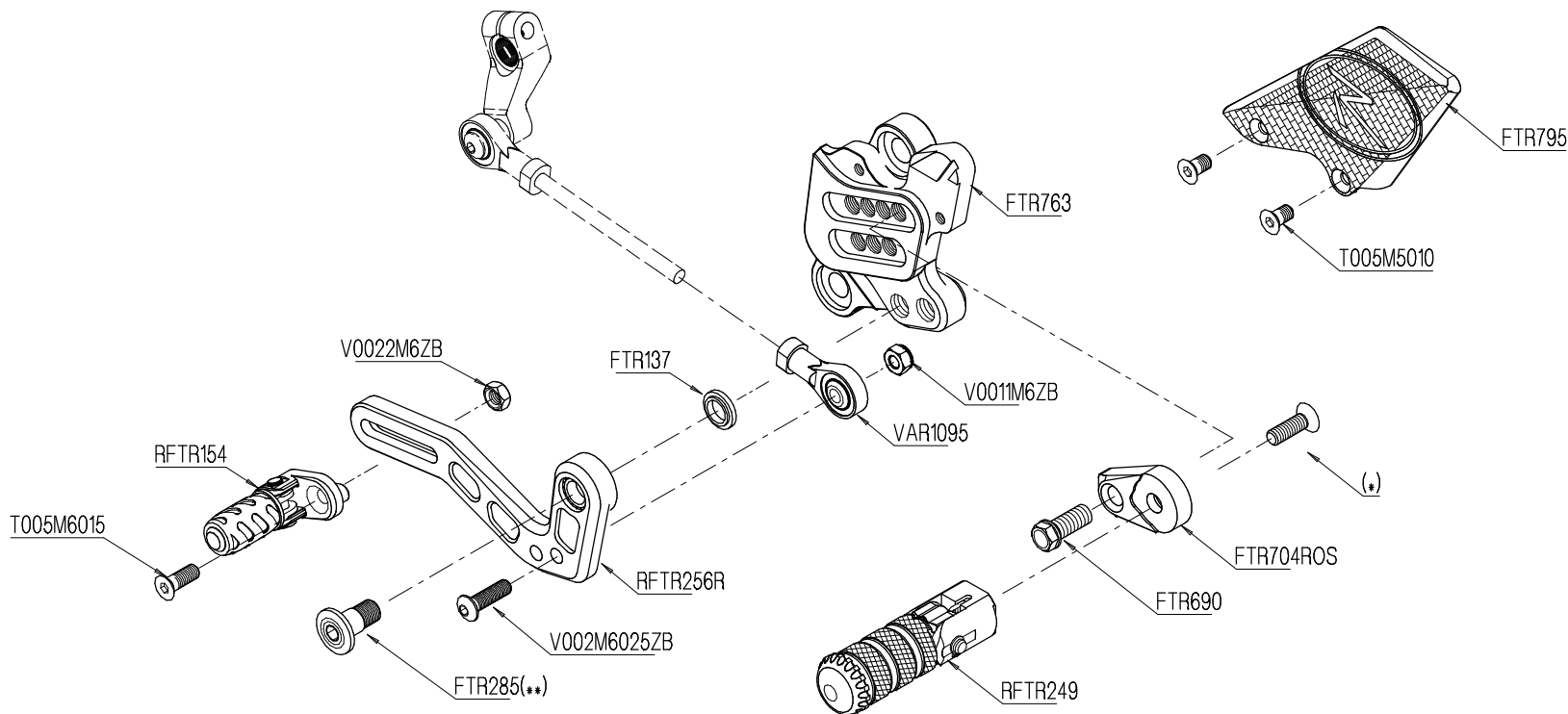
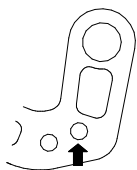
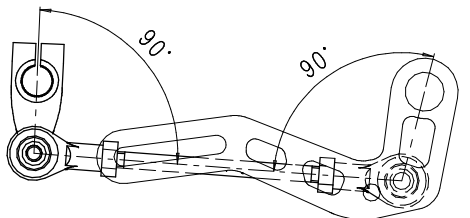

 IT) E' necessario l'intervento di personale professionale per tutti i prodotti che necessitano di installazione.  
 EN) The assistance of professional staff is necessary for all parts which require installation.  
 ES) Se necesita que sea montado por profesionales para todos los productos que necesitan instalacion.  
 FR) L'assistance d'un professionnel est necessaire pour toutes les pieces qui necessitent une installation.  
 DEU) Der Eingriff von Fachpersonal ist notwendig fur alle Artikel die installiert/montiert werden mussen.

ITALIA
VITE ORIGINALE
PARTE ORIGINALE
(*) BLOCCARE CON FRENAFILETTI DEBOLE
(**) BLOCCARE CON FRENAFILETTI MEDIO
MONTAGGIO CAMBIO NORMALE
MONTAGGIO CAMBIO ROVESCiato
VERIFICARE SERRAGGIO VITI PRIMA DELL'UTILIZZO
PRIMA DI ORDINARE VERIFICARE L'ULTIMA RELEASE SUL SITO

ENGLAND
OEM SCREW
OEM PART
(*) LOCKING WITH LOW STRENGTH THREAD LOCKER
(**) LOCKING WITH MEDIUM STRENGTH THREAD LOCKER
NORMAL MODE
REVERSE MODE
CONTROL THE TIGHTENING'S SCREW BEFORE USING
BEFORE ORDER CHECKING THE LATEST RELEASE ON WEBSITE

FRANCE
ECROU ORIGINE
PIECE ORIGINE
(*) BLOCCAGE AVEC FREIN FILET FAIBLE
(**) BLOCCAGE AVEC FREIN FILET MOYENNE
MONTAGE VITESSE NORMALE
MONTAGE VITESSE INVERSEE
VERIFIER SERRAGE AVANT UTILISATION
AVANT DE ORDONNER ON DOIT VERIFIER LA DERNIERE RELEASE SUR LE SITE INTERNET

DEUTSCHLAND
ORIGINAL SCHRAUBE
ORIGINAL TEIL
(*) BEFESTIGEN MIT SWACH SCHRAUBEN SICHERUNGSMITTEL
(**) BEFESTIGEN MIT MITTLEREN SCHRAUBEN SICHERUNGSMITTEL
EinBAU MIT NORMALE SCHALTUNG
EinBAU MIT GEKIPPTe SCHALTHeBEL
VOR DEN GEBRAUCH SCHRAUBEN PRUFEN
VOR DER BESTELLUNG UBERPRUFEN SIE BITTE DIE LETZTE VERSION DIESER ARTIKEL AUF DER INTERNET SEITE VON LIGHTECH

ESPAÑA
TORNILLO ORIGINAL
PIEZA ORIGINAL
(*) SELLAR CON SELLADOR DEBIL
(**) SELLAR CON SELLADOR MEDIO
MONTAJE CAMBIO NORMAL
MONTAJE CAMBIO INVERSO
VERIFICAR EL APRIETE ANTES DE UTILIZARLO
ANTES DE HACER EL PEDIDO, VERIFICAR LA ULTIMA VERSION EN LA WEB LIGHTECH

# KAWASAKI NINJA 400 (18) - FTRKA007R

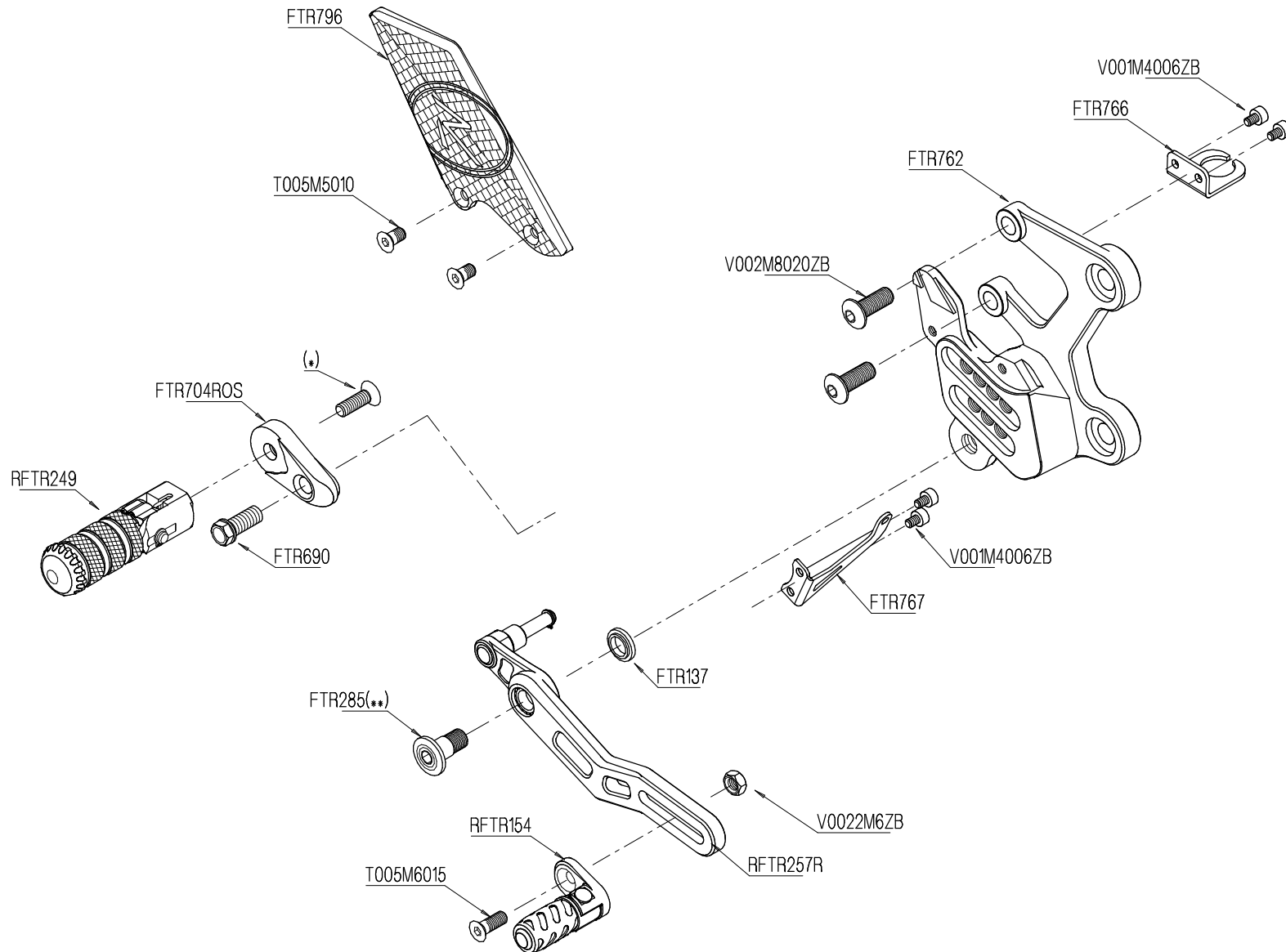

ITALIA
VITE ORIGINALE
PARTE ORIGINALE
(*) BLOCCARE CON FRENAFILETTI DEBOLE
(**) BLOCCARE CON FRENAFILETTI MEDIO
MONTAGGIO CAMBIO NORMALE
MONTAGGIO CAMBIO ROVESCIATO
VERIFICARE SERRAGGIO VITI PRIMA DELL'UTILIZZO
PRIMA DI ORDINARE VERIFICARE L'ULTIMA RELEASE SUL SITO

ENGLAND
OEM SCREW
OEM PART
(*) LOCKING WITH LOW STRENGTH THREAD LOCKER
(**) LOCKING WITH MEDIUM STRENGTH THREAD LOCKER
NORMAL MODE
REVERSE MODE
CONTROL THE TIGHTENING'S SCREW BEFORE USING
BEFORE ORDER CHECKING THE LATEST RELEASE ON WEBSITE

FRANCE
ECROU ORIGINE
PIECE ORIGINE
(*) BLOCCAGE AVEC FREIN FILET FAIBLE
(**) BLOCCAGE AVEC FREIN FILET MOYENNE
MONTAGE VITESSE NORMALE
MONTAGE VITESSE INVERSEE
VERIFIER SERRAGE AVANT UTILISATION
AVANT DE ORDONNER ON DOIT VERIFIER LA DERNIERE
RELEASE SUR LE SITE INTERNET

DEUTSCHLAND
ORIGINAL SCHRAUBE
ORIGINAL TEIL
(*) BEFESTIGEN MIT SWACH SCHRAUBEN SICHERUNGSMITTEL
(**) BEFESTIGEN MIT MITTLEREN SCHRAUBEN SICHERUNGSMITTEL
EINBAU MIT NORMALE SCHALTUNG
EINBAU MIT GEKIPPTER SCHALTHEBEL
VOR DEN GEBRAUCH SCHRAUBEN PRUFEN
VOR DER BESTELLUNG UBERPRUFEN SIE BITTE DIE LETZTE VERSION
DIESER ARTIKEL AUF DER INTERNET SEITE VON LIGHTTECH

ESPAÑA
TORNILLO ORIGINAL
PIEZA ORIGINAL
(*) SELLAR CON SELLADOR DEBIL
(**) SELLAR CON SELLADOR MEDIO
MONTAJE CAMBIO NORMAL
MONTAJE CAMBIO INVERSO
VERIFICAR EL APRIETE ANTES DE UTILIZARLO
ANTES DE HACER EL PEDIDO, VERIFICAR LA ULTIMA
VERSION EN LA WEB LIGHTTECH