

STOCK 6mm

THIS SHEET INCLUDES FITTING INSTRUCTIONS FOR THE FOLLOWING PARTS:

Secondary STOCK Alternator Cover Part No. EC-D675-1-GBR / Secondary Clutch Cover Part No. EC-D675-2-GBR /

Secondary Pulse Cover Part No. EC-D675-3-GBR

Bullet Frame Race Slider Set - STREET - Part No. FS-675-2006-CS-S / Bobbin Set Part No. BA12-6-GBR-SET /

Lower Chain Guard Part No. CGA06-GBR / Front Spindle Protectors Part No. BA-675-SET-GBR



SECONDARY ALTERNATOR COVER - **STOCK** - PART NO. EC-D675-1-GBR

- 1 Remove 4 off existing Bolts on the stock aluminium Alternator cover that correspond to the Secondary Alternator Cover.
- 2 Place the Secondary Alternator Cover over the stock aluminium alternator cover.
- 3 Loosely assemble M6x30 Bolts 1, 2, 3 & 4 in an anti clockwise direction, starting at Bolt Position 1.
- 4 Tighten all 4 bolts to a torque of 8 N/m as per manufacturer's recommendations.
DO NOT OVERTIGHTEN

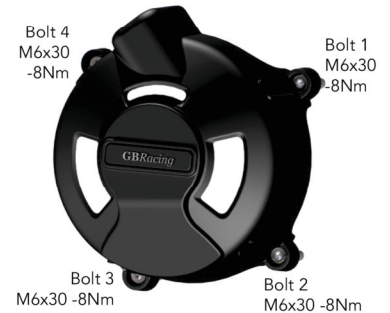
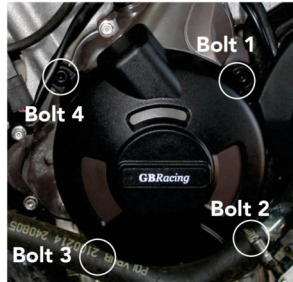

SECONDARY CLUTCH COVER PART NO. EC-D675-2-GBR

- 1 Remove 4 off existing Bolts on the stock aluminium Clutch cover that correspond to the Secondary Clutch Cover.
- 2 Place the Secondary Clutch Cover over the stock aluminium clutch cover.
- 3 Loosely assemble M6x30 Bolts 1, 2, 3 & 4 in an anti clockwise direction, starting at Bolt Position 1.
- 4 Tighten all 4 bolts to a torque of 8 N/m as per manufacturer's recommendations.
DO NOT OVERTIGHTEN

Note: You may need to bend the moulded arm at Bolt 4 to line up correctly

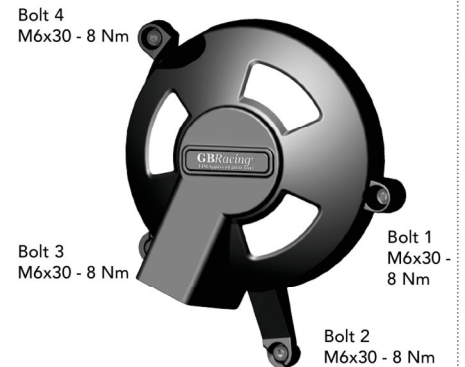
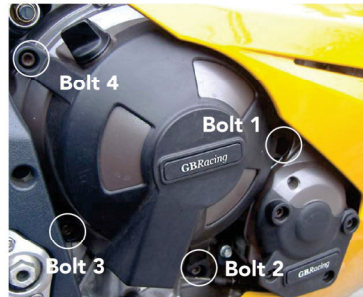

SECONDARY PULSE COVER PART NO. EC-D675-3-GBR

- 1 Remove 4 off existing Bolts at the base of the stock aluminium Pulse cover.
- 2 Place the Secondary Pulse Cover over the stock aluminium Pulse cover.
- 3 Loosely assemble the top 2 M6x30 Bolts 1&2 then assemble the bottom 2 M6x25 Bolts 3&4.
- 4 Tighten all 4 bolts to a torque of 8 N/m as per manufacturer's recommendations.
DO NOT OVERTIGHTEN

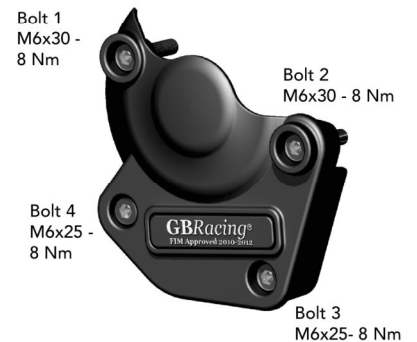
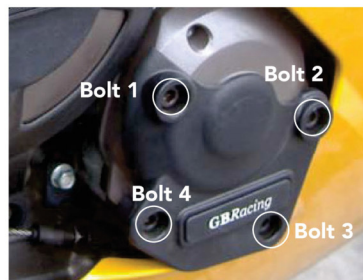

LOWER CHAIN GUARD PART NO. CGA06-GBR

- 1 Assemble 2 off M6 washers on to 2 off M6 x 20mm Bolts
- 2 Line up the Moulded Chain Guard to the Swing Arm bosses.
- 3 Assemble the M6 bolts through the 2 fixing holes on the aligned chain guard.
- 4 Assemble remaining 2 off M6 washers & M6 Lock Nuts onto the M6 bolts
DO NOT OVERTIGHTEN.

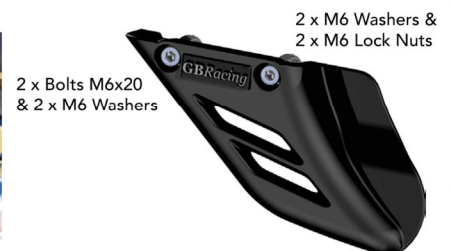

PADDOCK STAND / BOBBIN SET PART NO. BA12-6-GBR-SET

- 1 Assemble M6 x 40mm Bolt & M6 Washer through the moulded bobbin.
- 2 Tighten bolts to swing arm boss, 8 Nm.
DO NOT OVERTIGHTEN

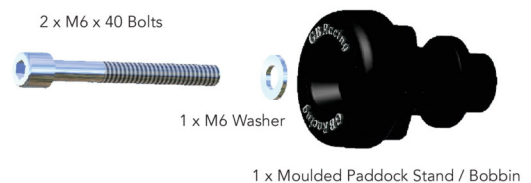

STOCK 6mm

BULLET FRAME SLIDER - LEFT HAND SIDE - STREET

PART NO. FS-675-2006-LHS-SET-S

1. Remove left side fairing
2. Unscrew engine bolts 1 & 2 as shown. Retain M10 locking nuts from Bolt 1.
3. Assemble black anodised bracket. Use 1 off M10 x 120 x 1.25 & 1 off M10 x 60 x 1.25 nickel plated bolts. Re-use the original M10 locking nut.

Note: You may need to loosen the Air Breather Bottle temporarily.

4. Tighten both bolts to 48 N/m, as per manufacturers recommendations.
5. Re-assemble Left side fairing
6. Assemble Crash Mushroom FS-675-2006-LHS-S. Tighten to 25 N/m DO NOT OVERTIGHTEN

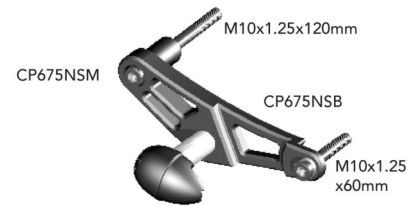
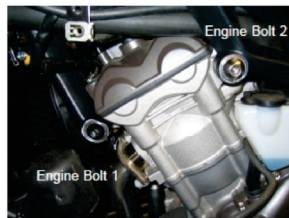

BULLET FRAME SLIDER - RIGHT HAND SIDE - STREET

PART NO. FS-675-2006-RHS-SET-S

1. Remove right side fairing
2. Unscrew engine bolts 1 & 2 as shown. Retain M10 locking nuts from Bolt 1.
3. Assemble black anodised bracket. Use 1 off M10 x 120 x 1.25 & 1 off M10 x 60 x 1.25 nickel plated bolts. Re-use the original M10 locking nut.

Note: You may need to loosen the Air Breather Bottle temporarily.

4. Tighten both bolts to 48 N/m, as per manufacturers recommendations.
5. Re-assemble Right side fairing
6. Assemble Crash Mushroom FS-675-2006-LHS-S. Tighten to 25 N/m. DO NOT OVERTIGHTEN

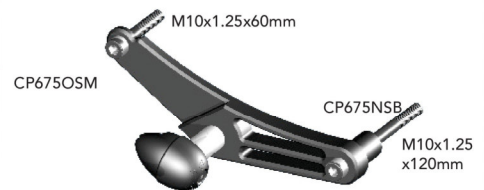
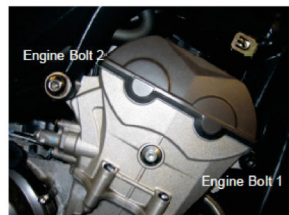

FRONT SPINDLE PROTECTORS - LEFT HAND SIDE

PART NO. BA-675-LHS-GBR

- 1 Assemble the Stainless Steel bar through the front spindle.
- 2 Place the Left Hand Side spindle protector assembly over the bar.
- 3 Assemble the M6 Washer first, then the lock nut. (The Washer must be used).
Note: You can prevent the bar from rotating by holding the opposite end of the bar by the slot providing with a flat headed screw driver.
- 4 When both ends are fitted, tighten the lock nuts together to a Torque of 10Nm. There should be approximately 2-3 threads equally showing over the lock nuts. DO NOT OVERTIGHTEN.

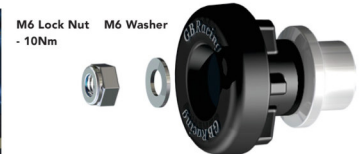

FRONT SPINDLE PROTECTORS - LEFT HAND SIDE

PART NO. BA-675-LHS-GBR

- 1 Assemble the Stainless Steel bar through the front spindle.
- 2 Place the Right Hand Side spindle protector assembly over the bar.
- 3 Assemble the M6 Washer first, then the lock nut. (The Washer must be used).
Note: You can prevent the bar from rotating by holding the opposite end of the bar by the slot providing with a flat headed screw driver.
- 4 When both ends are fitted, tighten the lock nuts together to a Torque of 10Nm. There should be approximately 2-3 threads equally showing over the lock nuts. DO NOT OVERTIGHTEN.

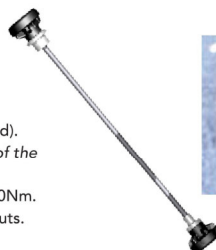

www.GBRacing.de

Protection Bundle: CP675-CS-GBR

EC-D675-1-GBR, EC-D675-2-GBR, EC-D675-3-GBR, CGA06-GBR, BA12-6-GBR-SET, BA-675-GBR-SET, FS-675-2006-CS-S

Engine Cover Set: EC-D675-SET-GBR

EC-D675-1-GBR, EC-D675-2-GBR, EC-D675-3-GBR